

## Clar and sextet polynomials of buckminsterfullerene

SHIU, Wai Chee; Lam, Peter Che Bor; Zhang, Heping

*Published in:*

Journal of Molecular Structure: THEOCHEM

*DOI:*

[10.1016/S0166-1280\(02\)00649-8](https://doi.org/10.1016/S0166-1280(02)00649-8)

Published: 19/03/2003

[Link to publication](#)

*Citation for published version (APA):*

SHIU, W. C., Lam, P. C. B., & Zhang, H. (2003). Clar and sextet polynomials of buckminsterfullerene. *Journal of Molecular Structure: THEOCHEM*, 622(3), 239-248. [https://doi.org/10.1016/S0166-1280\(02\)00649-8](https://doi.org/10.1016/S0166-1280(02)00649-8)

### General rights

Copyright and intellectual property rights for the publications made accessible in HKBU Scholars are retained by the authors and/or other copyright owners. In addition to the restrictions prescribed by the Copyright Ordinance of Hong Kong, all users and readers must also observe the following terms of use:

- Users may download and print one copy of any publication from HKBU Scholars for the purpose of private study or research
- Users cannot further distribute the material or use it for any profit-making activity or commercial gain
- To share publications in HKBU Scholars with others, users are welcome to freely distribute the permanent publication URLs

# Clar and sextet polynomials of buckminsterfullerene\*

Wai-Chee Shiu<sup>a</sup>, Peter Che Bor Lam<sup>a</sup>, Heping Zhang<sup>b</sup>

<sup>a</sup>Department of Mathematics, Hong Kong Baptist University  
Kowloon Tong, Hong Kong, China  
e-mail: wshiu@hkbu.edu.hk, cblam@hkbu.edu.hk

<sup>b</sup>Department of Mathematics, Lanzhou University, Lanzhou  
Gansu 730000, China. e-mail: zhanghp@lzu.edu.cn

## Abstract

A graph-theoretical definition of Herndon and Hosoya's Clar structure is given. The Fries Kekulé structure of buckminsterfullerene ( $C_{60}$ ) with  $I_h$  symmetry implies that every independent set of hexagon-dual graph (dodecahedron) of  $C_{60}$  corresponds to a sextet pattern; and every maximal independent set to a Clar structure. By proposing the maximal independent set polynomial of a graph and developing its various calculational methods the Clar polynomial of  $C_{60}$ ,  $\xi(C_{60}, \chi) = 5\chi^8 + 280\chi^7 + 10\chi^6$ , is given, which says that  $C_{60}$  possesses a total of 295 Clar structures, and thus corrects a corresponding result recently published. Furthermore, the sextet polynomial of  $C_{60}$  is also produced.

**Keywords:** Clar structure, Clar polynomial, sextet polynomial, buckminsterfullerene, graph theory

**AMS 2000 MSC:** 92E10, 05C90, 05C30

## 1 Introduction

Buckminsterfullerene ( $C_{60}$ , carbon football) [1] is a prominent member of carbon-clusters with an elegant truncated-icosahedron structure and the most stability in its all isomers, which has been attracting attention of many scientists since its discovery in 1985. In connection with  $\pi$  resonance stabilization developed originally for planar aromatic hydrocarbons [2, 3], the Kekulé structure count 12500 [4, 5] and, in general, matching polynomial [6] of  $C_{60}$  were reported.

---

\*This work is partially supported by FRG, Hong Kong Baptist University, National Natural Science Foundation of China and TRAPOYT.

$C_{60}$  has a special (Fries) Kekulé structure [7], i.e., it avoids double bonds in pentagons and maximize the number of benzenoid (alternating single-double-bonds) hexagons (see Fig. 1). Its importance in leading resonance stabilization is closely related to Clar's ideas [8] concerning aromaticity of planar hydrocarbons. Those fullerenes with such Fries Kekulé structure are thus referred to *Clar sextet fullerenes* [9], or equivalently *leapfrog fullerenes* [10]. In [11] El-Basil discussed Clar sextet theory of  $C_{60}$ , and computed the count of Clar structures of  $C_{60}$  and the associated Clar polynomial by considering the fragment-technique previously appeared [12] in benzenoid hydrocarbons.

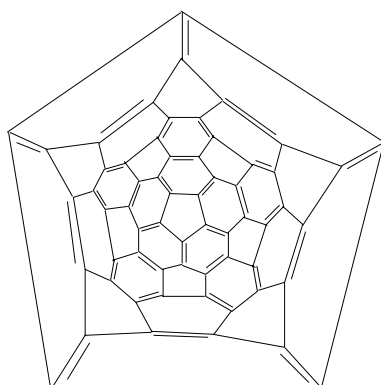

Fig. 1. Schlegel-diagram of Buckminsterfullerene ( $C_{60}$ ) with the Fries Kekulé structure.

A set of pairwise disjoint edges of a graph that cover all vertices of  $G$  is called a *Kekulé structure*, which coincides with perfect matching and 1-factor in graph theory. Let  $G$  be a plane or spherical graph with a Kekulé structure. A Clar structure was originally defined by Clar [8] as follows:

- (a) it is not allowed to draw circles in adjacent hexagons;
- (b) circles can be drawn in hexagons if the rest of  $G$  has at least one Kekulé structure (if it is empty, the empty set can be viewed as its Kekulé structure); and
- (c) a Clar structure contains the maximum possible number of circles which can be drawn using (a) and (b).

For example, Clar structures of coronene and  $C_{60}$  are referred to Fig. 2. For benzenoid systems, the computation problem of Clar structure was solved in 1998 by Abeledo and Atkinson [13], following linear programming approach [14].

El-Basil [11] showed recently that  $C_{60}$  has exactly five proper Clar structures, which can be generated by rotating that Clar structure of  $C_{60}$  shown in Fig. 2. Each one has the maximum possible number ( $=8$ ) of Clar's cycles and the hexagons inscribed such cycles cover only 48 of the carbon atoms of  $C_{60}$ , which is consistent with its electron-deficient chemistry.

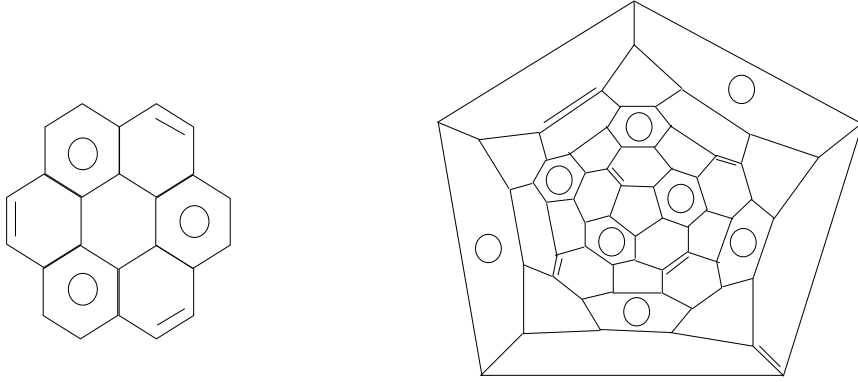

Fig. 2. Proper Clar structures of coronene and  $C_{60}$ .

There are various extensions of Clar structures. Herndon and Hosoya [15] alleviated rule (c) to define an (extended) Clar structures for calculating the resonance energies with more accuracy. Graph-theoretical algorithms for carrying out the calculations were also illustrated. El-Basil and Randić [12, 16, 17] et al. described such an extension of Clar structures and gave various construction approaches. For some large benzenoid systems, however, there are different explanations.

So it is necessary to clarify such an extended Clar structure by replacing (c) by (d) the set of circles is maximal, i.e., no new cycle can be drawn using (a) and (b).

It is consistent with the original idea of Herndon and Hosoya.

A Clar structure is viewed as a Clar valence structure having inscribed cycles together with a full arrangement of double bonds in the rest. We would like to give a more precisely graph-theoretical definition of Clar structures. Let  $G$  be a plane or spherical graph with a perfect matching. A spanning subgraph of  $G$  is called *Clar cover* (a special case of Sachs subgraph) [18] if each component is either a hexagon or  $K_2$  (the complete graph of two vertices). A Clar cover of  $G$  is called a *Clar structure* if the set of hexagons is maximal (in the sense of set-inclusion) in all Clar covers of  $G$ ; and *proper* Clar structure if the number of hexagons is as many as possible in all Clar covers of  $G$ .

The count polynomial of Clar structures, referred to as *Clar polynomial*, was defined by El-Basil and Randić [12, 16, 17] for a benzenoid system  $G$ :

$$\xi(G; \chi) = \sum_{i=0}^m \rho(G, i) \chi^i, \quad (1)$$

where  $\rho(G, i)$  is the number of Clar structures of  $G$  with  $i$  circles and  $m$  is the Clar number [14] (the number of cycles of a proper Clar structure of  $G$ ).

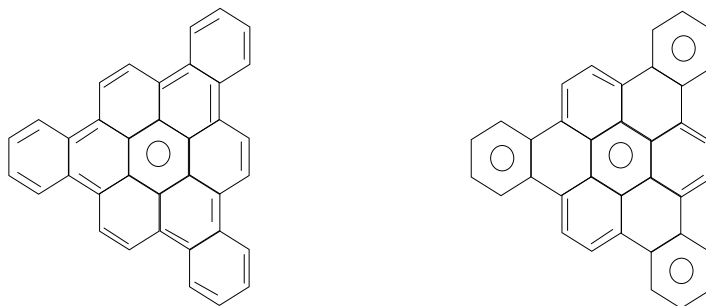

Fig. 3. Two Clar covers of tribenzo(a,g,m)coronene.

The left diagram is a non-Clar structure and the right diagram is a Clar structure

In [17] Randić et al. pointed out that the left diagram shown in Fig. 3 is not viewed as a Clar structure of tribenzo(a,g,m)coronene; while the right diagram in Fig. 3 is its Clar structure. The Clar polynomial of tribenzo(a,g,m)coronene reads  $\chi^6 + 4\chi^4 + 4\chi^3$ , which is consistent with the definition above.

In [11] El-Basil gave the Clar polynomial of  $C_{60}$  as  $\xi(C_{60}, \chi) = 5\chi^8 + 320\chi^7 + 5\chi^6$ . However, it is easily seen that  $C_{60}$  possesses (exactly) ten Clar structures with 6 cycles each, of which two types are indicated in Fig. 4 and each type contains 5 Clar structures.

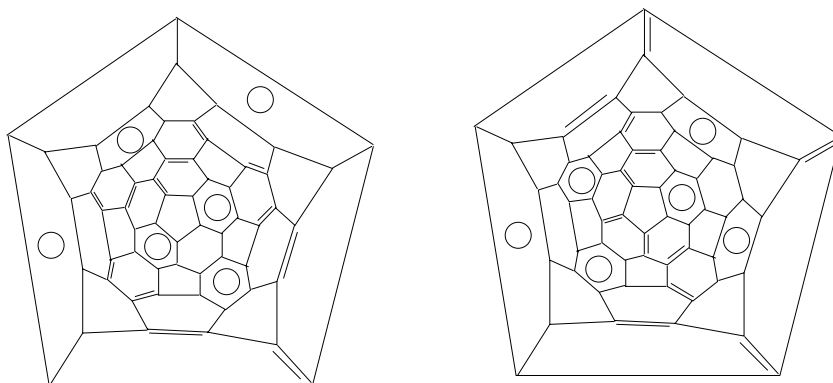

Fig. 4. Two types of 10 Clar structures of  $C_{60}$  with minimum number 6 of cycles.

We now would like to describe a curious finding:  $C_{60}$  has a Kekulé structure (see the left diagram in Fig. 5) for which no hexagon is alternating in double and single bonds. For benzenoid systems, however, this situation cannot happen. Further there exist much Clar covers of  $C_{60}$  with less than 6 hexagons and without conjugated 6-circuits (a *conjugated  $2n$ -circuit* is a circuit of  $2n$  vertices whose edges are alternating in double and single bonds). For example, see Fig. 5.

In this work the explicit expression of the Clar polynomial of  $C_{60}$  (Eq. (14)) is rigorously deduced by proposing graph-theoretical approaches as  $\xi(C_{60}, \chi) = 5\chi^8 + 280\chi^7 + 10\chi^6$ , and El-Basil's result is thus corrected.

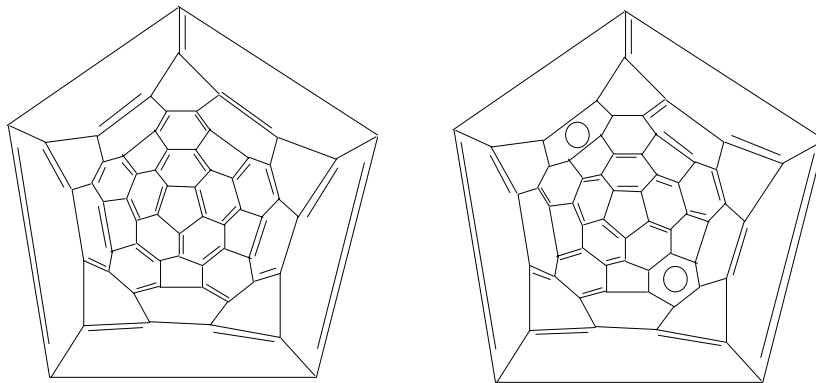

Fig. 5. Two Clar covers of  $C_{60}$  without hexagons containing three double bonds and three single bonds.

We now describe an alternative extension of Clar structure. A set  $S$  of pairwise disjoint hexagons in a plane or spherical graph (or conjugated system)  $G$  is called a *sextet pattern* if the subgraph  $G - S$  obtained from  $G$  by removing all vertices of hexagons in  $S$  together with their incident edges has at least one Kekulé structure. Then a sextet pattern is referred to a *usual generalized Clar formula*, a maximum sextet pattern (in a sense of the size of a set) to a *Clar formula*, and a maximal sextet pattern (in a sense of set-inclusion) together with a perfect matching of the rest to a Clar structure.

The *sextet polynomial* of a benzenoid system  $G$  for counting sextet patterns was introduced by Hosoya and Yamaguchi [19] as follows:

$$B_G(x) = \sum_{i=0}^m \sigma(G, i)x^i, \quad (2)$$

where  $\sigma(G, i)$  denotes the number of sextet patterns of  $G$  with  $i$  hexagons. The sextet polynomial of  $C_{60}$  is computed as  $B_{C_{60}}(x) = 5x^8 + 320x^7 + 1240x^6 + 1912x^5 + 1510x^4 + 660x^3 + 160x^2 + 20x + 1$ .

It can be easily computed that  $B_{C_{60}}(1) = 5288$ , which is less than the Kekulé structure count 12,500. For a thin benzenoid system,  $B_G(1) = K(G)$ , the number of Kekulé structures, that is, there exists a one-to-one correspondence between the sextet patterns and Kekulé structures. In general,  $B_G(1) \leq K(G)$ . Zhang and Chen [20] gave a complete characterization for  $B_G(1) = K(G)$ . The validity of such an equation can be extended to “fat benzenoid systems” (containing a coronene) by defining [21] the “supersextet” i.e. that equation holds for the corrected sextet polynomial.

In this paper we always use  $C_{60}$  and  $C_{20}$  to represent the molecular graphs of buckminsterfullerene and dodecahedron respectively. Some terminology of graph theory unexplained in this paper is referred to some textbooks, for instance, [22].

## 2 Some properties on $C_{60}$ and its hexagon-dual

The  $C_{60}$  is a hollow, closed-cage carbon molecule with the shape of a truncated icosahedron, which can be viewed as a spherically cubic graph with  $I_h$  symmetry (in mathematical terminology,  $I_h$  is the symmetry group of  $C_{60}$ ), 60 vertices, 20 hexagon-faces and 12 pairwise disjoint pentagon-faces. Among all  $C_{60}$  isomers only buckminsterfullerene has the Fries Kekulé structure where all hexagons have three conjugated double bonds while all pentagons are empty [9, 10]. Its Schlegel-diagram projection with the Fries Kekulé structure is referred to Fig. 1.

The Fries Kekulé structure implies a fact: any set  $S$  of pairwise disjoint hexagons of  $C_{60}$  is a sextet pattern, i.e. a generalized Clar formula. This is because the restriction of such Fries Kekulé structure on  $C_{60} - S$  remains a Kekulé structure of the rest, where  $C_{60} - S$  denotes the subgraph obtained from  $C_{60}$  by deleting all vertices of hexagons in  $S$  together with their incident edges. In particular, we have the following property on Clar structures of  $C_{60}$ .

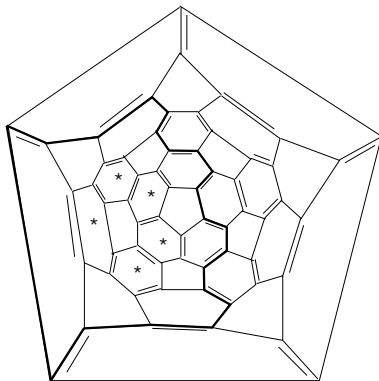

Fig. 6. Illustration for the proof of Theorem 2.1, a conjugated 20-circuit is indicated by a thick line.

**Theorem 2.1** *For any maximal sextet pattern  $S$  (in a sense of set-inclusion)  $S$  of  $C_{60}$ , the remainder  $C_{60} - S$  has a unique Kekulé structure.*

**Proof.** Let  $K$  be the Fries Kekulé structure of  $C_{60}$  and  $S$  any given maximal sextet pattern. Recall that all hexagons of  $C_{60}$  has three double bonds while all pentagons are empty in  $K$ . Let  $G = C_{60} - S$ . It is obvious that the restriction  $K_0 = K|_G$  is a Kekulé structure of  $G$ .

It suffices to show that  $K_0$  is a unique Kekulé structure of  $G$ . By contrary, suppose that  $G$  has at least two Kekulé structures. Then it follows that  $G$  has a  $K_0$ -conjugated circuit  $C$ ; that means that the edges of  $C$  are alternately double and single bonds along one way of  $C$ . It is obvious that  $C$  is not a hexagon; otherwise,  $S \cup \{C\}$  would be a larger sextet pattern than  $S$ , a contradiction. Since every edge not in a hexagon

$h$  but incident with  $h$  is single bond (not in  $K$ ), if  $C$  contains an edge of a hexagon  $h$  in the  $C_{60}$ , each component of the intersection  $C \cap h$  of  $C$  and  $h$  is a path of odd length and both end-edges of which are double bonds. It follows that  $C \cap h$  must be a path of  $h$  with length 3; otherwise  $C$  contains three double bonds of  $h$  or  $h'$ , where  $h'$  is another hexagon sharing an edge of  $h$ . Then either  $S \cup \{h\}$  or  $S \cup \{h'\}$  is a larger sextet pattern. Accordingly, it follows that  $C$  is a  $K$ -conjugated circuit of length 20 and has a unique form in a symmetric sense of  $C_{60}$  (see Fig. 6). The five hexagons (starred hexagons in Fig. 6) in the interior of  $C$  must belong to  $S$ ; otherwise their double bonds and  $C$  would form  $K$ -conjugated hexagons of  $G$ , a contradiction. These five hexagons forming a cyclic chain, however, are never pairwise disjoint; that is, they could not be fully contained in  $S$ , again contradiction.  $\square$

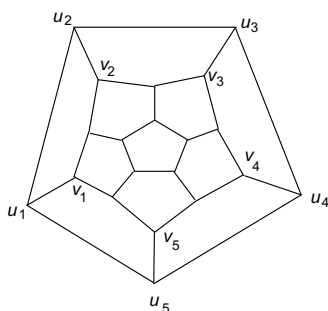

Fig. 7. Dodecahedron ( $C_{20}$ ).

The theorem implies a natural one-to-one correspondence between the Clar structures and the maximal sextet patterns of  $C_{60}$ . For benzenoid systems, the corresponding result holds [23] for *maximum* sextet patterns; not necessarily holds for *maximal* sextet patterns.

Thus we need to introduce the following concept: the *hexagon-dual* of  $C_{60}$  is a graph on the set of hexagons such that two vertices are connected by an edge provided that the corresponding hexagons sharing an edge. The following result is thus obvious.

**Lemma 2.2** *The hexagon-dual of  $C_{60}$  is the dodecahedron ( $C_{20}$ , see Fig. 7).*

Hence there is natural one-to-one correspondences between the sextet patterns of  $C_{60}$  and the independent sets of the dodecahedron graph, and between the Clar structures of  $C_{60}$  and the maximal independent sets of  $C_{20}$ . The Clar polynomial and sextet polynomial of  $C_{60}$  fully rely on the hexagon-dual, dodecahedron.

It should be mentioned that the hexagon-dual of  $C_{60}$  (buckminsterfullerene) is simply Fowler's leapfrog transform [10] in reverse. On the other hand, the Clar graph [24] of  $C_{60}$  is  $C_{20}$  in a natural extensive sense, since each pair of disjoint hexagons compose of a sextet pattern. For a large benzenoid system or other fullerene  $G$  there



is not necessarily a one-to-one correspondence between the (extended) Clar structures and the maximal independent sets of the Clar graph of  $G$ .

To compute the Clar polynomial of  $C_{60}$ , we now propose a novel graph polynomial, called the *maximal independent set polynomial*. Let  $G$  be graph. A set of vertices of  $G$  is called an *independent set* (abbreviated IS) if no two vertices are adjacent (the empty set is allowed); further *maximal independent set* (abbreviated MIS) if it cannot be properly contained in other independent set of  $G$ . The *maximal independent set (MIS) polynomial* of  $G$  is defined as follows

$$I_m(G, x) = \sum_T x^{|T|} = \sum_k \beta(G, k)x^k, \quad (3)$$

where the first summation goes over all MISs  $T$  of  $G$  and  $\beta(G, k)$  denotes the number of MISs of  $G$  with exactly  $k$  vertices. The *independent set (IS) polynomial* of  $G$  was previously defined [24, 25] as follows

$$I(G, x) = \sum_{k=0}^{\alpha} b(G, k)x^k, \quad (4)$$

where  $\alpha$  is the independent number of  $G$  (the size of a maximum independent set of  $G$ ),  $b(G, 0) = 1$  and  $b(G, k)$  denotes the number of  $k$ -independent sets of  $G$ . For brevity, we sometimes write  $I_m(G)$  and  $I(G)$  for  $I_m(G, x)$  and  $I(G, x)$  respectively.

From the above analysis we easily establish the following relations.

**Theorem 2.3**  $\xi(C_{60}, x) = I_m(C_{20}, x)$ .

**Theorem 2.4**  $B_{C_{60}}(x) = I(C_{20}, x)$ .

Accordingly, we shall compute the MIS and IS polynomials of the dodecahedron graph by developing some reduction methods in subsequent sections.

### 3 Clar polynomial

In this section we mainly intend to compute the Clar polynomial of  $C_{60}$ . From Theorem 2.3 we first develop some computational methods of MIS polynomials of graphs. The following result is obvious.

**Lemma 3.1** *If a graph  $G$  is the disjoint union of graphs  $G'$  and  $G''$ , then we have*

$$I_m(G, x) = I_m(G', x) \cdot I_m(G'', x). \quad (5)$$

**Proof.** It follows from the fact that a set of vertices of  $G$  is an MIS if and only if its restriction on  $H$  is also an MIS of  $H$  for each  $H = G'$  and  $G''$ .  $\square$

Let  $G$  be a graph with vertex-set  $V(G)$  and edge-set  $E(G)$ . For a set  $U$  of vertices of  $G$ , denote  $\langle U \rangle$  the subgraph of  $G$  induced by  $U$ , that is a graph on  $U$  such that the adjacency of vertices remains as in  $G$ ;  $N(U)$  the set of vertices in  $V(G) \setminus U$  adjacent to a vertex of  $U$  and  $N[U] = N(U) \cup U$ . For a set of vertices  $T \subseteq V(G) \setminus U$ , we say that  $T$  *dominates*  $U$  if every vertex in  $U$  has a neighbor in  $T$ . In particular, if  $U = \{u\}$ , i.e. it contains a single vertex, we simply write  $N(u)$  and  $N[u]$  for  $N(\{u\})$  and  $N[\{u\}]$  respectively. For a set  $T$ , we always denote  $|T|$  its cardinality.

**Lemma 3.2** *An independent set  $T$  of  $G$  is maximal if and only if  $N[T] = V(G)$ , i.e.  $T$  dominates  $\bar{T} = V(G) \setminus T$ .*

**Proof.** It follows from the definition of an MIS.  $\square$

Note that such a  $T$  is also called an independent dominating set [26].

For an induced subgraph  $H$  of  $G$ , we define the *restricted MIS polynomial* of  $H$  with respect to  $U \subseteq V(G) \setminus V(H)$  as follows.

$$I_m^*(H, x) = \sum_T x^{|T|}, \quad (6)$$

where the summation goes over all MISs  $T$  of  $H$  which dominate  $U$ .

**Theorem 3.3** *Let  $G$  be a graph and  $U \subseteq V(G)$ . Then*

$$I_m(G, x) = \sum_T x^{|T|} I_m^*(G - N[T] - U, x), \quad (7)$$

where the summation goes over all independent sets  $T$  of  $\langle U \rangle$  and  $I_m^*(G - N[T] - U, x)$  is the restricted MIS polynomial of  $G - N[T] - U$  with respect to  $U \setminus N[T]$ .

**Proof.** It is obvious that the restriction of any MIS of  $G$  on  $U$  is an independent set of  $\langle U \rangle$ . Let  $T$  be any independent set of  $\langle U \rangle$ . For any MIS  $I$  of  $G$  whose restriction on  $\langle U \rangle$  is  $T$ , by Lemma 3.2 we have that  $I \setminus N[T]$  is an MIS of  $G - N[T] - U$  and dominates  $U \setminus N[T]$ . Hence the contribution of such MISs of  $G$  whose restriction on  $U$  is  $T$  to the MIS polynomial of  $G$  is  $x^{|T|} I_m^*(G - N[T] - U, x)$ . The result follows.  $\square$

**Theorem 3.4** *Let  $G$  be a graph with a vertex  $u$ . Then*

$$I_m(G, x) = x I_m(G - N[u], x) + \sum_T (-1)^{|T|-1} x^{|T|} I_m(G - N[T], x), \quad (8)$$

where the summation goes over all non-empty independent sets  $T$  in the graph  $\langle N(u) \rangle$ .

**Proof.** Applying Theorem 3.3 and the general Principle of Inclusion and Exclusion (in weighted type) [27, P. 158], we will prove this result.

Let  $U = \{u\}$ . Then  $\langle\{u\}\rangle$  has two ISs  $T = \{u\}$  and  $\emptyset$ . It is obvious that the former corresponds the first term  $xI_m(G - N[u], x)$  in Eq. (8). So in the following we mainly treat the case  $T = \emptyset$ , that is, we want to compute the restricted MIS polynomial  $I_m^*(G - N[T] - U, x) = I_m^*(G - u, x)$  with respect to  $\{u\}$ .

For a set  $T \subseteq V(G)$ , we define its weight as  $w(T) = x^{|T|}$ . For a family  $\mathcal{T}$  of subsets of  $V(G)$ , its weight is defined as  $W(\mathcal{T}) = \sum_{T \in \mathcal{T}} w(T)$ ; if  $\mathcal{T} = \emptyset$ , in particular,  $W(\mathcal{T}) = 0$ .

Let  $\mathcal{I}$  denote the family of all MISs of  $G - u$  which dominate  $\{u\}$ . Then each member of  $\mathcal{I}$  has a non-empty restriction on  $N(u)$ , which is also an independent set of  $\langle N(u) \rangle$ . For a vertex  $v \in N(u)$ , Let  $\mathcal{I}_v$  denote the set of members of  $\mathcal{I}$  containing a vertex  $v$ . Then by the general principle of inclusion and exclusion we have that

$$W(\mathcal{I}) = \sum_{\emptyset \neq T \subseteq N(u)} (-1)^{|T|-1} W\left(\bigcap_{v \in T} \mathcal{I}_v\right).$$

If  $T$  is not independent in  $\langle N(u) \rangle$ , then  $\bigcap_{v \in T} \mathcal{I}_v = \emptyset$ ; that is, no member of  $\mathcal{I}$  contain  $T$  and thus  $W\left(\bigcap_{v \in T} \mathcal{I}_v\right) = 0$ . Otherwise,  $W\left(\bigcap_{v \in T} \mathcal{I}_v\right) = x^{|T|} I_m(G - N[T], x)$ . Hence

$$I_m^*(G - u, x) = W(\mathcal{I}) = \sum_T (-1)^{|T|-1} x^{|T|} I_m(G - N[T], x),$$

where the summation goes over all non-empty independent sets of  $\langle N(u) \rangle$ . So the theorem follows.  $\square$

As an immediate consequence, we have

**Corollary 3.5** *Assume that a graph  $G$  has a vertex  $u$  of degree one and  $v$  is its neighbor. Then*

$$I_m(G, x) = xI_m(G - N[u], x) + xI_m(G - N[v], x). \quad (9)$$

The corollary implies the following recurrence relation for path  $P_n$  of  $n$  vertices:

$$I_m(P_n, x) = xI_m(P_{n-2}, x) + xI_m(P_{n-3}, x), n \geq 3 \quad (10)$$

with initial conditions  $I_m(P_0, x) = 1$ ,  $I_m(P_1, x) = x$  and  $I_m(P_2, x) = 2x$ .

Now we are going to compute the polynomial  $I_m(C_{20}, x)$  by applying some reduction methods derived above. In the Schlegel-diagram of  $C_{20}$  (Fig. 7), we choose the peripheral pentagon as a reduction reference. Let  $U$  denote the five vertices, labelled clockwise by  $u_1, \dots, u_5$ , lying on the boundary. Then  $\langle U \rangle$  is an induced circuit of  $C_{20}$  and  $N(U) = \{v_1, \dots, v_5\}$  is an independent set of  $C_{20}$ , where  $v_i$  is adjacent to  $u_i$  for all  $i$ . Let  $T$  be an independent set of the circuit  $\langle U \rangle$ . There are three cases to be distinguished:

Case 1:  $|T| = 0$ . MISs of  $G - U$  dominating  $U \setminus N[T] = U$  must contain  $N(U)$ . Thus the restricted MIS polynomial  $I_m^*(G - U, x)$  with respect to  $U$  is equal to

$$x^5 I_m(\text{pentagon}, x) = x^5 \cdot 5x^2 = 5x^7.$$

Case 2:  $|T| = 1$ . For instance,  $T = \{u_1\}$ . MISs of  $G - U - v_1$  dominating  $\{u_3, u_4\}$  must contain  $\{v_3, v_4\}$ . Thus the restricted MIS polynomial  $I_m^*(G - U - v_1, x)$  with respect to  $\{u_3, u_4\}$  is equal to  $x^2 I_m(G - N[u_1, v_3, v_4], x) = x^2 I_m(G_2, x)$ , where  $G_2$  is shown in Fig. 8.

Case 3:  $|T| = 2$ . For instance,  $T = \{u_1, u_3\}$ . It is obvious that the restricted MIS polynomial  $I_m^*(G - N[u_1, u_3], x)$  with respect to  $U \setminus N[T] = \emptyset$  equals the MIS polynomial  $I_m(G - N[u_1, u_3], x) = I_m(G_3, x)$ , where  $G_3$  is shown in Fig. 8.

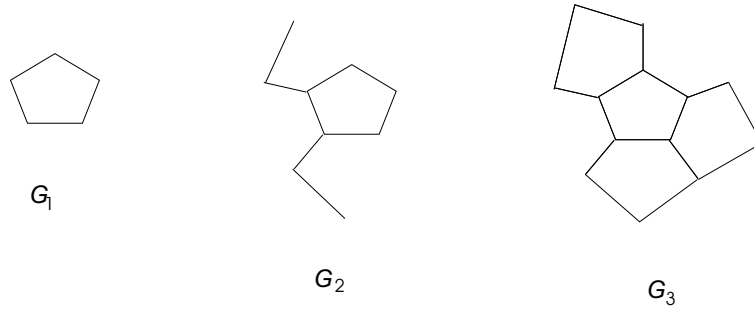

Fig. 8. Subgraphs  $G_1$ ,  $G_2$  and  $G_3$  appeared in some reductions of  $C_{20}$ .

By Theorem 3.3 we have

$$I_m(C_{20}, x) = x^5 I_m(\text{pentagon}, x) + 5x^3 I_m(G_2, x) + 5x^2 I_m(G_3, x). \quad (11)$$

For subgraphs  $G_2$  and  $G_3$  of  $C_{60}$  occurred in the above reductions, we further choose their central pentagon as reduction reference. By the analogous argument (Theorem 3.3 together with the recurrence relation (10)), we have

$$I_m(G_2, x) = 0 + x \cdot x^2 + x^2 \cdot (I_m^2(P_2) + 4I_m(P_1)I_m(P_2)) = 12x^4 + x^3, \quad (12)$$

and

$$\begin{aligned} I_m(G_3, x) &= x^5 + x(x^2 I_m^2(P_2) + 4x^2 I_m(P_2)I_m(P_1)) \\ &\quad + x^2(I_m^2(P_3) + 2I_m(P_2)I_m(P_4) + 2I_m^3(P_2)) \\ &= x^6 + 43x^5 + x^4. \end{aligned} \quad (13)$$

Substituting these equalities (12) and (13) into Eq. (11), we finally arrive at the Clar polynomial of  $C_{60}$  as follows

$$\xi(C_{60}, \chi) = I_m(C_{20}, \chi) = 5\chi^8 + 280\chi^7 + 10\chi^6. \quad (14)$$

Eq. (14) implies that  $C_{60}$  possesses exactly 10 Clar structures of  $C_{60}$  with exactly 6 cycles (see Fig. 4) and the number of its Clar structures of Herndon and Hosoya reads  $\xi(\text{HH}) = \xi(C_{60}, 1) = 295$ .

## 4 Sextet polynomial

To compute the sextet polynomial of  $C_{60}$ , by Theorem 2.4 we only need to consider the IS polynomial of  $C_{20}$ . Such type of graph polynomial was ever introduced under the name “independent polynomial” for various utilities, see [25, 24] with cited references therein. So we now recall some properties on the IS polynomial of a graph. Following are three well-known lemmas [25, 24].

**Lemma 4.1** *If a graph  $G$  is the disjoint union of graphs  $G'$  and  $G''$ , then we have*

$$I(G, x) = I(G', x) \cdot I(G'', x). \quad (15)$$

**Lemma 4.2** *Let  $u$  be a vertex of  $G$ . Then*

$$I(G, x) = I(G - u, x) + xI(G - N[u], x). \quad (16)$$

**Lemma 4.3** *Let  $P_n$  be a path with  $n$  vertices. Then the IS polynomial  $I(P_n, x)$  has the recurrence relation  $I(P_n, x) = I(P_{n-1}, x) + xI(P_{n-2}, x)$ ,  $n \geq 2$ , with initial conditions  $I(P_0, x) = 1$  and  $I(P_1, x) = 1 + x$  and the explicit expression as follows.*

$$I(P_n, x) = \sum_{k=0}^{\lceil n/2 \rceil} \binom{n-k+1}{k} x^k. \quad (17)$$

The general subgraph expansion of IS polynomial of a graph was described in [25]. For our convenience, the following reduction method is derived.

**Theorem 4.4** *Let  $G$  be a graph and  $U$  a set of vertices of  $G$ . Then*

$$I(G, x) = \sum_T x^{|T|} I(G - U - N(T), x), \quad (18)$$

where the summation goes over all independent sets  $T$  of the graph  $\langle U \rangle$ .

**Proof.** For any independent set of  $G$ , its restriction on  $U$  is also an independent set of  $\langle U \rangle$ . For any given independent set  $T$  of  $\langle U \rangle$ , let  $\mathcal{I}_T$  denote the family of independent sets of  $G$  whose restriction on  $\langle U \rangle$  is  $T$ . Since such distinct families are pairwise disjoint, adopting the same weight as in the proof of Theorem 3.3 we have

$$I(G, x) = \sum_{T \subseteq U} W(\mathcal{I}_T) = \sum_{T \subseteq U} x^{|T|} I(G - U - N(T), x),$$

where the summations go over all independent sets  $T$  of  $\langle U \rangle$ .  $\square$

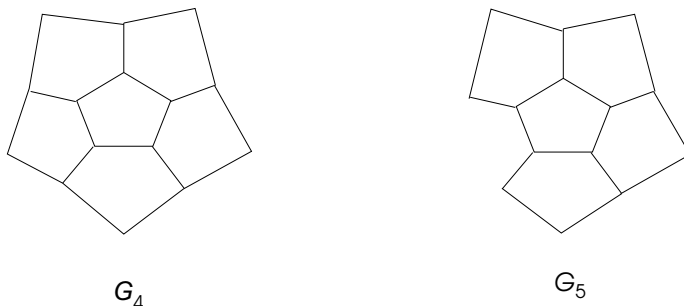

Fig. 9. Subgraphs  $G_4$  and  $G_5$  appeared in some reductions of the dodecahedron.

Now we are going to compute the independent set polynomial of  $C_{20}$  by applying some reduction method appeared in this section. We also choose the peripheral pentagon of  $C_{20}$  as a reduction reference. By Theorem 4.4 we have

$$I(C_{20}, x) = I(G_4, x) + 5xI(G_5, x) + 5x^2I(G_3, x), \quad (19)$$

where  $G_3$  is referred to Fig. 8, both  $G_4$  and  $G_5$  are referred to Fig. 9.

By some analogous reduction techniques, furthermore we have that

$$\begin{aligned} I(G_4, x) &= I(10\text{-gon}) + 5xI(P_9) + 5x^2I(P_3)I(P_5) \\ &= (5x + 1)I(P_9) + xI(P_7) + 5x^2I(P_3)I(P_5) \\ &= 1 + 15x + 85x^2 + 230x^3 + 310x^4 + 197x^5 + 50x^6 + 5x^7, \end{aligned} \quad (20)$$

$$\begin{aligned} I(G_5, x) &= I(P_9) + x(2I(P_8) + 2I(P_2)I(P_6) + I^2(P_4)) \\ &\quad + x^2(2I(P_2)I(P_5) + 2I(P_3)I(P_4) + I^2(P_2)I(P_3)) \\ &= 1 + 14x + 73x^2 + 178x^3 + 208x^4 + 104x^5 + 14x^6, \end{aligned} \quad (21)$$

and

$$\begin{aligned} I(G_3, x) &= I(P_3)I(P_5) + x(2I(P_2)I(P_5) + 2I(P_3)I(P_4) + I(P_3)I^2(P_2)) \\ &\quad + x^2(2I(P_2)I(P_4) + 2I^3(P_2) + I^2(P_3)) \\ &= 1 + 13x + 62x^2 + 135x^3 + 134x^4 + 49x^5 + x^6. \end{aligned} \quad (22)$$

By substituting the Eqs. (20) to (22) into (19) we arrive at the following explicit expression of the sextet polynomial of  $C_{60}$

$$\begin{aligned} B_{C_{60}}(x) &= I(C_{20}, x) \\ &= 5x^8 + 320x^7 + 1240x^6 + 1912x^5 + 1510x^4 + 660x^3 + 160x^2 + 20x + 1. \end{aligned} \quad (23)$$

From Eq. (23), we know that  $C_{60}$  contains a total of  $B_{C_{60}}(1) = 5288$  sextet patterns. This number is only little more than one third Kekulé structure count of  $C_{60}$ .

Finally we would like to mention that some polynomial operations in the above computations (for example, Eqs. (12)-(14) and (20)-(23)) are accomplished in MATH-EMATICA. The computational techniques of sextet polynomial used in this paper are suitable for all polycyclic conjugated systems which contain such a dominant Kekulé structure that each hexagon is a conjugated 6-circuit.

## References

- [1] W. H. Kroto, J. R. Heath, S. C. O'Brien, R. F. Curl, R. E. Smalley, *Nature*, 318(1985), 162-163.
- [2] W. C. Herndon, *J. Am. Chem. Soc.*, 95(1973), 2404-2406.
- [3] M. Randić, *Chem. Phys. Lett.*, 38(1976), 68-70.
- [4] E. Brendsdal and S.J. Cyvin, *J. Mol. Struct. (Theochem)*, 188(1989), 55.
- [5] D.J. Klein, T.G. Schmalz, G.E. Hile, W.A. Seitz, *J. Am. Chem. Soc.*, 108(1986), 1301.
- [6] H. Hosoya, *Comput. Math. Appl.*, 12B(1986), 271.
- [7] K. Fries, *Justus Liebigs Ann. Chem.*, 454(1927), 121-324.
- [8] E. Clar, *The Aromatic Sextet*, Wiley, New York, 1972.
- [9] X. Liu, D.J. Klein, T.G. Schmalz, *Fullerene Sci. Techn.*, 2(4)(1994), 405-422.
- [10] P. Fowler and T. Pisanski, *J. Chem. Soc. Faraday Trans.*, 90(19)(1994), 2865-2871.
- [11] S. El-Basil, *J. Mol. Struct. (Theochem)*, 531(2000), 9-21.
- [12] M. Randić and S. El-Basil, *J. Mol. Struct. (Theochem)*, 304(1994), 233-245.
- [13] H. Abeledo and G. Atkinson, *Polyhedral combinatorics of benzenoid problems*, *Lect. Notes Comput. Sci.*, 1412(1998), 202-212.
- [14] P. Hansen and M. Zheng, *J. Math. Chem.*, 15(1994), 93-107.
- [15] W. C. Herndon and H. Hosoya, *Tetrahedron*, 40(1984), 3987-3995.
- [16] S. El-Basil, *Theor. Chem. Acta*, 70(1986), 53-65.
- [17] M. Randić, S. El-Basil, S. Nikolić, and N. Trinajstić, *J. Chem. Inf. Comput. Sci.*, 38(4)(1998), 563 -574.
- [18] H. Zhang and F. Zhang, *Discrete Appl. Math.*, 69(1996), 147-167.
- [19] H. Hosoya and T. Yamaguchi, *Tetrahedron Lett.*, 1975, 4659-4662.
- [20] F. Zhang and R. Chen, *Match* 19 (1986)179.
- [21] N. Ohkami, A. Motoyama, T. Yamaguchi, H. Hosoya, I. Gutman, *Tetrahedron*, 37(1981), 1113-1122.

- [22] J. A. Bondy and U. S. R. Murty, Graph Theory with Applications, Macmillan, London, 1976.
- [23] M. Zheng and R. Chen, Graphs Combin., 1(1985), 295-298.
- [24] I. Gutman, Z. Naturforsch, 37a(1982), 69-73.
- [25] C. Hoede and X. Li, Discrete Math., 125(1994), 219-228.
- [26] P.C.B. Lam, W.C. Shiu and L. Sun, Discrete Math., 202(1999), 135-144.
- [27] M. Aigner, Combinatorial Theory, Springer-Verlag, Berlin, 1979.